



## **Cisco Wireless IP Phone 7920 for Cisco CallManger Express 3.2**

**INCLUDING LICENSE AND WARRANTY**

### **Corporate Headquarters**

Cisco Systems, Inc.  
170 West Tasman Drive  
San Jose, CA 95134-1706  
USA  
<http://www.cisco.com>  
Tel: 408 526-4000  
800 553-NETS (6387)  
Fax: 408 526-4100







# Contents

---

## **Preface 1**

About This Guide 1

Audience and Scope 1

Related Documentation 1

    Cisco 7920 Documentation 1

    Cisco IP Phone Documentation 2

Obtaining Documentation 2

    Cisco.com 2

    Documentation CD-ROM 2

    Ordering Documentation 3

    Documentation Feedback 3

Obtaining Technical Assistance 3

    Cisco.com 4

    Technical Assistance Center 4

        Cisco TAC Website 5

        Cisco TAC Escalation Center 5

Obtaining Additional Publications and Information 6

## **Getting Started 7**

Checking Shipment Completeness 7

How to Use this Guide 7

Safety Warnings 8

    Warning Definition 8

    Installation Warning 9

    Product Disposal Warning 9

    Lightning Activity Warning 9

    Battery Handling Warning 9

    Emergency Services Warning 9

Explosive Gas Warning	10
Battery Disposal Warning	10
Battery Safety Notices	10
Installing and Removing the Battery	11
Charging the Phone and the Battery	12
<b>Overview of the Cisco Wireless IP Phone 7920</b>	<b>14</b>
Powering the Phone On and Off	16
Main Screen and Display Indicators	17
Shortcut Keys for Phone Functions	18
Document Conventions	18
Using the Phone Menus	19
Setting Passwords	19
Setting the LEAP Username and Password	20
Entering and Editing Text	20
Entering Symbols into Text	21
Accessories	21
<b>Basic Call Handling</b>	<b>22</b>
Placing Calls	22
Answering and Ending Calls	23
Muting Calls	23
Adjusting the Speaker Volume	24
Placing Calls on Hold	24
Transferring Calls	25
Making Conference Calls	25
Forwarding Your Calls to Another Number	26
<b>Using Advanced Call Features</b>	<b>27</b>
Parking and Retrieving Parked Calls	27
Redirecting a Ringing Call to Your Phone By Using Call Pickup	27
Understanding Shared Lines	28
Using the Phone Book and Speed Dial Features	29

- Using the Phone Book 29
- Adding or Changing Entries in the Phone Book 30
- Configuring Speed Dial Hot Keys 31
- Using Voice Messaging and Call History Logs 33
  - Playing Voice Messages 33
  - Viewing and Placing Calls from the Call History Menu 34

## **Using and Changing Profiles 35**

- User Profiles 35
  - Options for User Profile Settings 36
  - Configuring User Profiles 36
- Network Profiles 38
  - Choosing a Network Profile 38

## **Using Cisco IP Phone Services 40**

- Logging In to the User Options Web Pages 40
- Subscribing to IP Phone Services 40
- Accessing IP Phone Services 41

## **Customizing Phone Settings and Viewing Phone Status 42**

- Change Phone Settings 42
  - Changing Ring Tone Settings 42
  - Changing Phone Display Settings 43
  - Changing Phone Access Settings 43
- Viewing Phone Status 44
  - Viewing the Network Configuration 45

## **Menu Diagrams and Display Messages 47**

- Menu Diagrams 47
- Display Messages 51
  - Informational Messages 52
  - Error Messages 53
  - Warning Messages 54

## **Index 55**





# Preface

---

This section covers the following topics:

- About This Guide, page 1
- Audience and Scope, page 1
- Related Documentation, page 1
- Obtaining Documentation, page 2
- Obtaining Technical Assistance, page 3
- Obtaining Additional Publications and Information, page 6

## About This Guide

This guide is designed to help you learn about basic and advanced features of, and phone and network configurations for, the Cisco Wireless IP Phone 7920.

## Audience and Scope

This guide is intended for the wireless phone user who may or may not have had any technical training in IP telephony or networking, and who is planning to use the Cisco Wireless IP Phone 7920 in an enterprise environment.

## Related Documentation

This section describes other publications in the Cisco 7920 Wireless IP Phone documentation set in addition to related Cisco publications.

## Cisco 7920 Documentation

The following publications are companion documents to the *Cisco Wireless IP Phone 7920 for Cisco CallManager Express 3.2*:

- For IP phone configuration, software installation, and operation instructions, refer to the *Cisco CallManager Express 3.2 System Administrator Guide*

- For Cisco Wireless IP Phone 7920 accessories, refer to the *Cisco Wireless IP Phone 7920 Accessory Guide*.
- For regulatory compliance and safety information, refer to the *Regulatory Compliance and Safety Information for the Cisco Wireless IP Phone 7920*.
- For the latest information about the *Cisco CallManager Express and Cisco IOS Telephony*, refer to the Cisco CallManager Express and Cisco IOS Telephony index at the following location:  
[http://www.cisco.com/univercd/cc/td/doc/product/access/ip\\_ph/ip\\_ks/index.htm](http://www.cisco.com/univercd/cc/td/doc/product/access/ip_ph/ip_ks/index.htm)

## Cisco IP Phone Documentation

Cisco IP Phone 7900 Series product documentation for the Cisco IP Phones including: 7902G, 7905G, 7910G+SW, 7912G, 7914 Expansion Module, Wireless IP Phone 7920, Conference Station 7935, 7940G, 7960G, 7970G, IP Manager Assistant, and CallManager Extended ServicesSoftPhone, see the the following URL.

[http://www.cisco.com/univercd/cc/td/doc/product/voice/c\\_ipphon/english/](http://www.cisco.com/univercd/cc/td/doc/product/voice/c_ipphon/english/)

## Obtaining Documentation

Cisco provides several ways to obtain documentation, technical assistance, and other technical resources. These sections explain how to obtain technical information from Cisco Systems.

### Cisco.com

You can access the most current Cisco documentation on the World Wide Web at this URL:

<http://www.cisco.com/univercd/home/home.htm>

You can access the Cisco website at this URL:

<http://www.cisco.com>

International Cisco websites can be accessed from this URL:

[http://www.cisco.com/public/countries\\_languages.shtml](http://www.cisco.com/public/countries_languages.shtml)

### Documentation CD-ROM

Cisco documentation and additional literature are available in a Cisco Documentation CD-ROM package, which may have shipped with your product. The Documentation CD-ROM is updated regularly and may be more current than printed documentation. The CD-ROM package is available as a single unit or through an annual or quarterly subscription.

Registered Cisco.com users can order a single Documentation CD-ROM (product number DOC-CONDOCCD=) through the Cisco Ordering tool:

[http://www.cisco.com/en/US/partner/ordering/ordering\\_place\\_order\\_ordering\\_tool\\_launch.html](http://www.cisco.com/en/US/partner/ordering/ordering_place_order_ordering_tool_launch.html)

All users can order monthly or quarterly subscriptions through the online Subscription Store:

<http://www.cisco.com/go/subscription>

## Ordering Documentation

You can find instructions for ordering documentation at this URL:

[http://www.cisco.com/univercd/cc/td/doc/es\\_inpk/pdi.htm](http://www.cisco.com/univercd/cc/td/doc/es_inpk/pdi.htm)

You can order Cisco documentation in these ways:

- Registered Cisco.com users (Cisco direct customers) can order Cisco product documentation from the Networking Products MarketPlace:  
<http://www.cisco.com/en/US/partner/ordering/index.shtml>
- Nonregistered Cisco.com users can order documentation through a local account representative by calling Cisco Systems Corporate Headquarters (California, U.S.A.) at 408 526-7208 or, elsewhere in North America, by calling 800 553-NETS (6387).

## Documentation Feedback

You can submit comments electronically on Cisco.com. On the Cisco Documentation home page, click **Feedback** at the top of the page.

You can e-mail your comments to [bug-doc@cisco.com](mailto:bug-doc@cisco.com).

You can submit comments by using the response card (if present) behind the front cover of your document or by writing to the following address:

Cisco Systems  
Attn: Customer Document Ordering  
170 West Tasman Drive  
San Jose, CA 95134-9883

We appreciate your comments.

## Obtaining Technical Assistance

Cisco provides Cisco.com, which includes the Cisco Technical Assistance Center (TAC) website, as a starting point for all technical assistance. Customers and partners can obtain online documentation, troubleshooting tips, and sample configurations from the Cisco TAC website. Cisco.com registered users have complete access to the technical support resources on the Cisco TAC website, including TAC tools and utilities.

## Cisco.com

Cisco.com offers a suite of interactive, networked services that let you access Cisco information, networking solutions, services, programs, and resources at any time, from anywhere in the world.

Cisco.com provides a broad range of features and services to help you with these tasks:

- Streamline business processes and improve productivity
- Resolve technical issues with online support
- Download and test software packages
- Order Cisco learning materials and merchandise
- Register for online skill assessment, training, and certification programs

To obtain customized information and service, you can self-register on Cisco.com at this URL:

<http://tools.cisco.com/RPF/register/register.do>

## Technical Assistance Center

The Cisco TAC is available to all customers who need technical assistance with a Cisco product, technology, or solution. Two types of support are available: the Cisco TAC website and the Cisco TAC Escalation Center. The type of support that you choose depends on the priority of the problem and the conditions stated in service contracts, when applicable.

We categorize Cisco TAC inquiries according to urgency:

- Priority level 4 (P4)—You need information or assistance concerning Cisco product capabilities, product installation, or basic product configuration. There is little or no impact to your business operations.
- Priority level 3 (P3)—Operational performance of the network is impaired, but most business operations remain functional. You and Cisco are willing to commit resources during normal business hours to restore service to satisfactory levels.
- Priority level 2 (P2)—Operation of an existing network is severely degraded, or significant aspects of your business operations are negatively impacted by inadequate performance of Cisco products. You and Cisco will commit full-time resources during normal business hours to resolve the situation.
- Priority level 1 (P1)—An existing network is “down,” or there is a critical impact to your business operations. You and Cisco will commit all necessary resources around the clock to resolve the situation.

## Cisco TAC Website

The Cisco TAC website provides online documents and tools to help troubleshoot and resolve technical issues with Cisco products and technologies. To access the Cisco TAC website, go to this URL:

<http://www.cisco.com/tac>

All customers, partners, and resellers who have a valid Cisco service contract have complete access to the technical support resources on the Cisco TAC website. Some services on the Cisco TAC website require a Cisco.com login ID and password. If you have a valid service contract but do not have a login ID or password, go to this URL to register:

<http://tools.cisco.com/RPF/register/register.do>

If you are a Cisco.com registered user, and you cannot resolve your technical issues by using the Cisco TAC website, you can open a case online at this URL:

<http://www.cisco.com/tac/caseopen>

If you have Internet access, we recommend that you open P3 and P4 cases online so that you can fully describe the situation and attach any necessary files.

## Cisco TAC Escalation Center

The Cisco TAC Escalation Center addresses priority level 1 or priority level 2 issues. These classifications are assigned when severe network degradation significantly impacts business operations. When you contact the TAC Escalation Center with a P1 or P2 problem, a Cisco TAC engineer automatically opens a case.

To obtain a directory of toll-free Cisco TAC telephone numbers for your country, go to this URL:

<http://www.cisco.com/warp/public/687/Directory/DirTAC.shtml>

Before calling, please check with your network operations center to determine the Cisco support services to which your company is entitled: for example, SMARTnet, SMARTnet Onsite, or Network Supported Accounts (NSA). When you call the center, please have available your service agreement number and your product serial number.

# Obtaining Additional Publications and Information

Information about Cisco products, technologies, and network solutions is available from various online and printed sources.

- The *Cisco Product Catalog* describes the networking products offered by Cisco Systems, as well as ordering and customer support services. Access the *Cisco Product Catalog* at this URL:  
[http://www.cisco.com/en/US/products/products\\_catalog\\_links\\_launch.html](http://www.cisco.com/en/US/products/products_catalog_links_launch.html)
  - Cisco Press publishes a wide range of networking publications. Cisco suggests these titles for new and experienced users: *Internetworking Terms and Acronyms Dictionary*, *Internetworking Technology Handbook*, *Internetworking Troubleshooting Guide*, and the *Internetworking Design Guide*. For current Cisco Press titles and other information, go to Cisco Press online at this URL:  
<http://www.ciscopress.com>
  - *Packet* magazine is the Cisco quarterly publication that provides the latest networking trends, technology breakthroughs, and Cisco products and solutions to help industry professionals get the most from their networking investment. Included are networking deployment and troubleshooting tips, configuration examples, customer case studies, tutorials and training, certification information, and links to numerous in-depth online resources. You can access *Packet* magazine at this URL:  
<http://www.cisco.com/go/packet>
  - iQ Magazine is the Cisco bimonthly publication that delivers the latest information about Internet business strategies for executives. You can access iQ Magazine at this URL:  
<http://www.cisco.com/go/iqmagazine>
  - Internet Protocol Journal is a quarterly journal published by Cisco Systems for engineering professionals involved in designing, developing, and operating public and private internets and intranets. You can access the Internet Protocol Journal at this URL:  
[http://www.cisco.com/en/US/about/ac123/ac147/about\\_cisco\\_the\\_internet\\_protocol\\_journal.html](http://www.cisco.com/en/US/about/ac123/ac147/about_cisco_the_internet_protocol_journal.html)
  - Training—Cisco offers world-class networking training. Current offerings in network training are listed at this URL:  
[http://www.cisco.com/en/US/learning/le31/learning\\_recommended\\_training\\_list.html](http://www.cisco.com/en/US/learning/le31/learning_recommended_training_list.html)
-

# Getting Started

---

Before using your Cisco Wireless IP Phone 7920, you need to do the following:

- Checking Shipment Completeness, page 7
- How to Use this Guide, page 7
- Safety Warnings, page 8
- Battery Safety Notices, page 10
- Installing and Removing the Battery, page 11
- Charging the Phone and the Battery, page 12

## Checking Shipment Completeness

Check to make sure that all items are present in the Cisco Wireless IP Phone 7920 box.

The package should contain the following:

- Cisco Wireless IP Phone 7920
- Standard battery (Cisco part number: CP-BATT-7920-STD)
- Power supply (Cisco part number: CP-PWR-7920SE-NA)
- Regulatory Compliance and Safety Information for the Cisco Wireless IP Phone 7920

Inform your system manager or supplier if any items are missing.

## How to Use this Guide

This guide provides you with an overview of the features that are available on your phone. For information about common tasks, refer to the following table. Contact your system administrator if you have problems or need more information about your phone.

If you want to...	Then...
<b>Review safety information</b>	See the “Safety Warnings” section on page 8.
<b>Install the battery</b>	See the “Installing and Removing the Battery” section on page 11.
<b>Charge the battery</b>	See the “Charging the Phone and the Battery” section on page 12.
<b>Use your phone</b>	Start with the “Overview of the Cisco Wireless IP Phone 7920” section on page 15.

<b>If you want to...</b>	<b>Then...</b>
<b>Set LEAP password</b>	See the “Setting the LEAP Username and Password” section on page 20.
<b>Understand the phone screen</b>	See the “Main Screen and Display Indicators” section on page 17.
<b>Make calls</b>	See the “Placing Calls” section on page 22.
<b>Change the speaker volume</b>	See the “Adjusting the Speaker Volume” section on page 33.
<b>Put calls on hold</b>	See the “Placing Calls on Hold” section on page 34.
<b>Transfer calls</b>	See the “Transferring Calls” section on page 35.
<b>Mute calls</b>	See the “Muting Calls” section on page 32.
<b>Make conference calls</b>	See the “Making Conference Calls” section on page 36.
<b>Listen to voice messages</b>	See the “Playing Voice Messages” section on page 55.
<b>Set up speed dial</b>	See the “Configuring Speed Dial Hot Keys” section on page 50.
<b>Lock and unlock the phone</b>	See the “Change Phone Settings” section on page 74
<b>Choose rings for different conditions</b>	See the “Configuring User Profiles” section on page 61.
<b>Set up a personal phone book</b>	See the “Using the Phone Book” section on page 46.
<b>Change ring tones</b>	See the “Changing Ring Tone Settings” section on page 74.
<b>Subscribe to phone applications and services</b>	See the “Subscribing to IP Phone Services” section on page 69.
<b>Get information about phone accessories</b>	See the “Accessories” section on page 21.

## Safety Warnings

These safety notices apply to the Cisco Wireless IP Phone 7920. Please read the following sections before installing or using your Cisco Wireless IP Phone 7920.

## Warning Definition



### Warning

**This warning symbol means danger. You are in a situation that could cause bodily injury. Before you work on any equipment, be aware of the hazards involved with electrical circuitry and be familiar with standard practices for preventing accidents. To see translations of the warnings that appear in this publication, refer to the translated safety warnings that accompanied this device.**

## Installation Warning



Warning

---

Read the installation instructions before connecting the system to the power source.

---

## Product Disposal Warning



Warning

---

Ultimate disposal of this product should be handled according to all national laws and regulations.

---

## Lightning Activity Warning



Warning

---

Do not work on the system or connect or disconnect cables during periods of lightning activity.

---

## Battery Handling Warning



Warning

---

There is the danger of explosion if the battery is replaced incorrectly. Replace the battery only with the same or equivalent type recommended by the manufacturer. Dispose of used batteries according to the manufacturer's instructions.

---

## Emergency Services Warning



Warning

---

This equipment will not be able to access emergency services during a power outage because of reliance on utility power for normal operation. Alternative arrangements should be made for access to emergency services. Access to emergency services can be affected by any call-barring function of this equipment.

---

## Explosive Gas Warning



### Warning

---

**The use of the Cisco Wireless IP Phone 7920 in hazardous environments such as areas where high levels of explosive gas may be present is not recommended. Check with the site safety engineer before using any type of wireless device in such an environment.**

---

## Battery Disposal Warning



### Warning

---

**Do not dispose of the battery pack in fire or water. The battery may explode if placed in the fire.**

---

## Battery Safety Notices

These battery safety notices apply to the batteries that are approved by the Cisco Wireless IP Phone 7920 manufacturer.



### Caution

---

This symbol means *reader be careful*. In this situation, you might do something that could result in equipment damage. Refer to the product documentation for instructions.

---



### Caution

---

The battery pack is intended for use only with this device.

---



### Caution

---

Do not disassemble, crush, puncture, or incinerate the battery pack.

---



### Caution

---

To avoid risk of fire, burns, or damage to your battery pack, do not allow a metal object to touch the battery contacts.

---



### Caution

---

Handle a damaged or leaking battery with extreme care. If you come in contact with the electrolyte, wash the exposed area with soap and water. If the electrolyte has come in contact the eye, flush the eye with water for 15 minutes and seek medical attention.

---

**Caution**

---

Do not charge the battery pack if the ambient temperature exceeds 104 degrees Fahrenheit (40 degrees Celsius).

---

**Caution**

---

Do not expose the battery pack to high storage temperatures (above 140 degrees Fahrenheit, 60 degrees Celsius).

---

**Caution**

---

When discarding a battery pack, contact your local waste disposal provider regarding local restrictions on the disposal or recycling of batteries.

---

**Caution**

---

To obtain a replacement battery, contact your local dealer. Use only the batteries that have one of the following Cisco part numbers: CP-BATT-7920-STD (standard battery) or CP-BATT-7920-EXT (extended use battery).

---

**Caution**

---

Use only the power supply that is provided by Cisco. The Cisco part numbers are: CP-PWR-7920-NA (for North America), CP-PWR-7920-CE (for Central Europe), CP-PWR-7920-UK (for United Kingdom), CP-PWR-7920-AU (for Australia), and CP-PWR-7920-JP (for Japan).

---

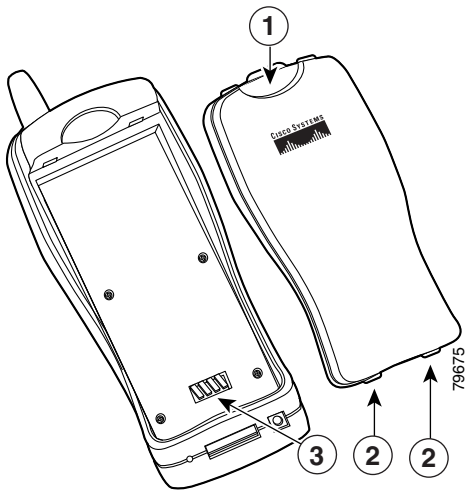
To see translations of the warnings that appear in this publication, refer to the *Regulatory Compliance and Safety Information for the Cisco Wireless IP Phone 7920* document that accompanied this product.

## Installing and Removing the Battery

You must install and charge the battery before you can use the Cisco Wireless IP Phone 7920. To install or remove the battery, follow these steps.

- 
- Step 1** To install the battery, insert the two catches of the battery (as shown in Figure 1) in the corresponding slots near the bottom of the Cisco Wireless IP Phone 7920. Make sure that the metal contacts on the battery and the phone are facing each other.
  - Step 2** Press the battery to the body of the phone until it locks into place.
  - Step 3** To remove the battery, press down on the locking catch of the battery. Then lift and remove the battery.

**Figure 1** *Installing and Removing the Battery*



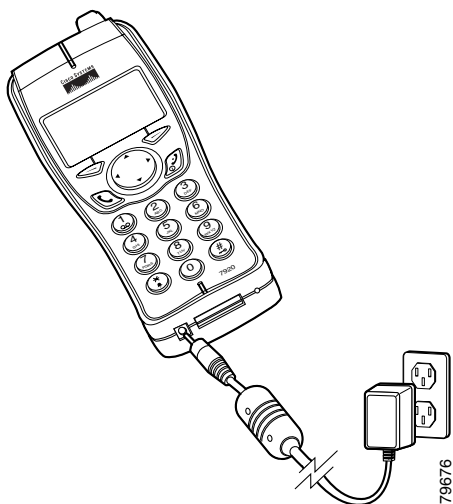
<b>1</b>	Locking catch—Press to release the battery.
<b>2</b>	Catches—Insert these into the slots near the bottom of the phone at battery installation.
<b>3</b>	Metal contact—Match the contact on the battery to the contact on the phone.

## Charging the Phone and the Battery

The Cisco Wireless IP Phone 7920 is powered by a rechargeable battery. To charge the battery when it is installed in the phone, follow these steps:

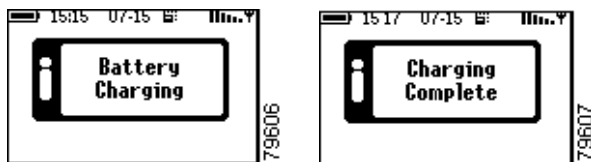
1. Connect the cable from the power supply to the base of the phone.
2. Connect the power supply to an AC wall outlet as shown in Figure 2.

**Figure 2** Charging the Phone and the Battery



If the phone is turned off, the screen displays the message “Battery Charging.” When the battery is fully charged, the “Charging Complete” message is displayed, as shown in Figure 3.

**Figure 3** Charging Battery Messages



If the phone is turned on, the battery indicator bar blinks, displaying the current power level. When the battery is fully charged, the battery indicator bar stops blinking.

3. When the battery is fully charged, disconnect the charger from the phone, and unplug the power cord from the AC wall outlet.
  - The standard battery requires about 3.5 hours to become fully charged and provides up to 3.5 hours of talk time or 21 hours of standby time.
  - The extended battery provides up to 4.25 hours of talk time or 30 hours of standby time. The battery becomes fully charged in about 4.5 hours. For more information about charging the battery, refer to the “Desktop Charger” section in the *Cisco Wireless IP Phone 7920 Accessory Guide*.

# Overview of the Cisco Wireless IP Phone 7920

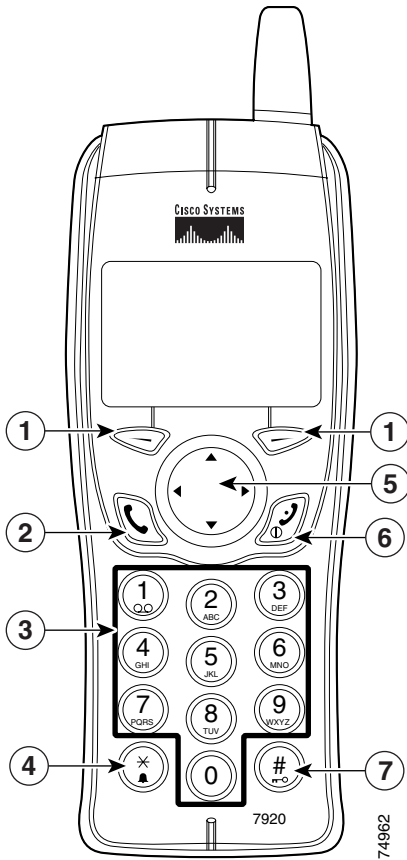
---

The Cisco Wireless IP Phone 7920 provides the following features:




- Wireless access to your corporate phone extension and phone services
- Multiline appearances
- Up to eight speed dial hot keys
- Caller ID for incoming calls
- Call handling features such as forward, transfer, hold, call park, conference, call pickup, and group pickup
- Softkey access to menus and your personal phone book
- Choice of profiles for personal use

The Cisco Wireless IP Phone 7920 is depicted in Figure 4 on page 15. The callout table describes the functions of the keys.


Figure 4 Cisco Wireless IP Phone 7920



1		Left and right softkeys—Activates the item in the label above the softkey.
2		Answer/Send key—Answers a call or dials a number.
3		Number keys (0-9)—Use these to enter numbers and characters. Number keys (2-9)—Use these to activate Speed Dial hot keys.
4		Asterisk (*) key—Toggles between ring and vibrate mode. Toggles between upper and lower case. See the “Entering and Editing Text” section on page 20.

5		Arrow key—Moves from one function to another. This guide uses these directional arrows ▲, ▼, ◀, or ▶.
6		Power/End key—Turns the phone on or off, silences a ringing call, or ends a connected call. See the “Answering and Ending Calls” section on page 32.
7		Pound (#) key—Toggles between locking and unlocking the key pad. Allows you to access special characters when you are entering text.

## Powering the Phone On and Off

To turn the phone on, press and hold the  key until the phone powers on. The phone connects to a wireless access point and begins authentication. In a Cisco Light Extensible Authentication Protocol (LEAP) environment, you might have to set the LEAP password. See the “Setting Passwords” section on page 19.

After completing authentication, the phone displays the main screen, as shown in Figure 5. The phone is in standby mode and is ready to place or receive calls. The signal icon in the upper right corner shows the strength of the signal between the wireless access point and your phone. Your phone must have an adequate signal before you can place or receive calls. The icon displays six vertical bars for a strong signal. If the icon displays fewer than three bars, the signal is weak.



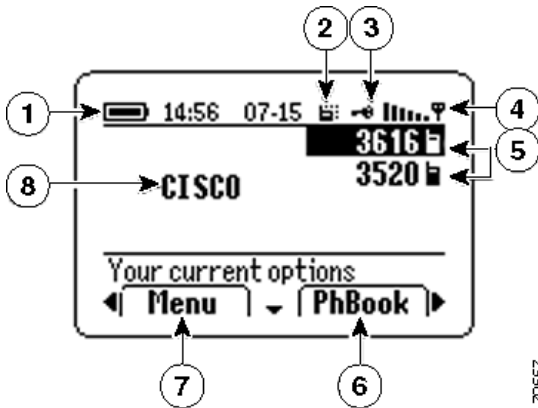
### Tip

When the phone receives a weak signal, the phone displays this warning message, “Weak signal detected” and sends a warning tone or vibration as specified in your active profile. See the “Configuring User Profiles” section on page 61 for more information.

## Main Screen and Display Indicators

Figure 5 shows the icons displayed in the Main screen, which is the screen that you see after you turn on the Cisco 7920 Wireless IP Phone.

**Figure 5** Main Screen/Standby Mode



1	Battery icon—Shows level of charge in battery
2	Vibration icon—Indicates vibration mode
3	Key lock icon—Indicates keypad is locked
4	Signal icon—Shows degree of signal strength
5	Extension numbers—Identify each phone line
6	Right softkey label—Displays the idle softkey ( <i>PhBook</i> or <i>Svcs</i> ) or a feature during a call
7	Left softkey label—Displays <i>Menu</i> or a feature option during a call
8	Welcome message—Shows modifiable message




















### Note

The LEAP password screen appears when the phone is switched on in a LEAP and Prompt mode activated environment. Contact your administrator to obtain the LEAP password. Or see the “Setting the LEAP Password” section on page 88.









# Shortcut Keys for Phone Functions

The phone keypad provides the following shortcuts to frequently used functions.

Shortcut Key	Function	Notes
	Locks or unlocks the phone keypad	Press and hold the  key. The  icon displays at the top of the Main screen. Press and hold the  key to toggle key lock off. The  icon disappears.
	Toggles between ringing and vibrating mode	Press and hold the  key. The screen displays “Vibration On” and the  icon appears at the top. To switch back to the ring mode, press and hold the  key. The screen displays “Vibration Off,” and the  icon disappears. The default setting is “ring mode.”
	Accesses voice messaging	Press and release the  key. The phone connects to your voice messaging system.
	Accesses the speaker volume adjustment	During a call, press the  arrow on the navigation key to access the volume adjustment screen. Increase the volume by pressing  or decrease the volume by pressing  on the navigation key.
 2–9	Activates the speed dial number	Press and hold one of the numeric keys (2–9) for the speed dial number that you want to use.

# Document Conventions


To simplify the instructions for using phone features and for changing phone settings, this guide uses the following conventions and terms.

Action Keys	Navigation Instructions in This Guide
Using  or  softkeys with labels	When you must press the softkey for a menu, feature, or action label, this guide states: Press (softkey label). Example: Press <b>PhBook</b>
Using the  or  arrows	To move left or right between menu tabs or softkey labels, this guide states: Use  or  to switch to (item name). Example: Use  or  to switch to the <b>Directory</b>

Action Keys	Navigation Instructions in This Guide
Using the ▲ or ▼ arrows	To move up or down between menu options or list items, this guide states: Scroll to (item name). Example: Scroll to <b>Speed Dial</b>
Using the “Select” softkey	When you must press the “Select” softkey to use a menu option or item that you have highlighted, this guide states: Select (item name). Example: Select <b>Speed Dial</b>
Using menus and options	To advance through several menu options, the guide states: Choose Menu > (menu option) > (menu option) Example: Choose <b>Menu &gt; Directory &gt; Phone Book &gt; Speed Dial</b>

## Using the Phone Menus

The phone menus provide access to phone features and settings. When you press **Menu**, the name of the first menu displays on your phone screen with a set of overlapping tabs for the other phone menus.

To access a specific menu, press ◀ or ▶ until you see the desired menu name, such as **Directory**. Press **Select** (by using ). Use ▲ or ▼ to scroll between the menu options.

To choose a menu option, such as **Speed Dial** in the **Directory** menu, scroll to **Speed Dial** and press **Select**.

This table lists reference information for the phone menus.

Menu	Section in Phone Guide
Directory	Using the Phone Book and Speed Dial Features, page 45.
Messages	Playing Voice Messages, page 55.
Call History	Viewing and Placing Calls from the Call History Menu, page 56.
Profiles	Using and Changing Profiles, page 59.
Services	Using Cisco IP Phone Services, page 67.
Phone Settings	Customizing Phone Settings and Viewing Phone Status, page 73.
Network Config	Viewing the Network Configuration, page 79

## Setting Passwords

When powering on your phone for the first time, you might need to set your LEAP username and password. Your system administrator can provide LEAP information.

You must access the Profiles menu, select Network Profile and navigate to the 802.11b Configuration options. Use the following steps to set your username and password.

## Setting the LEAP Username and Password

1. Press **Menu**, then press ◀ or ▶ until you see the **Profiles** menu, and press **Select**.
2. Scroll to **Network Profile** and press **Select**.
3. Scroll to the current profile name (with check mark) and press **Select**.
4. Scroll to **802.11b Configuration** and press **Select**.
5. Scroll to **LEAP** and press **Select**.
6. Scroll to **Username** or **Password** and press **Select**.

**Note**

Consult your system administrator for the username format and password information for your system.

7. Press **Edit** and enter your username or password. For assistance, see the “Entering and Editing Text” section on page 20.


**Note**






The LEAP password entry can be up to 32 characters.

8. Press **OK** to confirm the changes, then press **Back** several times to return to the main screen.

## Entering and Editing Text

You can enter characters, numbers, and special characters for passwords and phone book entries. When you press a numeric key on the keypad, a text bubble shows all the characters that this key controls. Each press moves to another character choice.

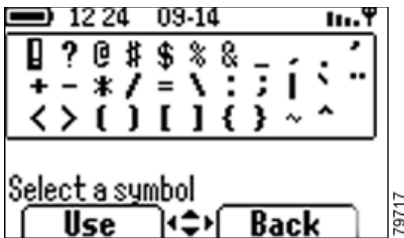
If you want to...	Then...
<b>Enter characters</b>	Press the numeric key once to enter the first character. Press it twice to enter the second character or press it three times to enter the third character.
<b>Enter numbers</b>	Press the numeric key four times to enter the number.
<b>Delete the last character</b>	Press <b>Clear</b> once to delete the last character or number in the string.
<b>Delete the entire string</b>	Press and hold <b>Clear</b> to delete the entire text or number string.
<b>Use upper case characters</b>	Press  to switch between uppercase and lowercase. <b>ABC</b> or <b>abc</b> appears on the right corner of the screen to indicate the case.
<b>Enter a space</b>	Press ▶ or ▼ to enter a space between characters.






If you want to...	Then...
Enter special characters and symbols	Press  . Doing so displays the symbol table, as shown in Figure 6. Use  ,  ,  , or  to select the desired symbol. Press Use to insert the symbol into your text.
Cancel editing mode	Press Back as needed to return to the menu option or main screen.

## Entering Symbols into Text

**Step 1** Press  to display the Symbol table, as shown in Figure 6.

**Figure 6** Symbol Table



- Use , , , or  to select the desired symbol.
- Press  to insert the symbol into your text.










## Accessories


See the *Cisco Wireless IP Phone 7920 Accessory Guide* for information about phone accessories.

# Basic Call Handling


Basic call-handling tasks such as placing, answering, transferring, and conferencing calls are available to most phone users.

## Placing Calls




<b>If you want to...</b>	<b>Then...</b>
<b>Dial a phone number</b>	Enter the phone number using the numerical keys.
<b>Delete the last digit dialed</b>	Press <b>Clear</b> to delete the last dialed digit. To delete the entire dialed number, press and hold <b>Clear</b> .
<b>Place the call</b>	After dialing, press  (green key) to place your call.
<b>Place the call on a secondary line</b>	Before or after dialing the number, press  to change to another line and press  to make the call.
<b>Redial the last dialed number</b>	Press  to switch to <b>Redial</b> , then press <b>Redial</b> to make the call.
<b>Redial a number from the list of previously placed calls</b>	Press  to display the list. Scroll to the desired phone number and press  to make the call. The previously placed calls list contains 10 records.
<b>Dial a phone number from your local phone book</b>	Press <b>PhBook</b> and scroll to the desired entry. Press  to dial the number. See the “Using the Phone Book” section on page 46 for more information.
<b>Speed dial a phone number using a Speed Dial hot key</b>	Press and hold  (2-9) for the Speed Dial number that you want to use. The phone displays and dials the number stored for that hot key. See the “Configuring Speed Dial Hot Keys” section on page 50.
<b>Dial from a corporate directory listing</b>	Choose <b>Menu &gt; Directory &gt; Corporate Directory</b> (exact name can vary). Search for a listing by using your keypad to enter letters and press <b>Search</b> . Scroll to the desired entry and choose <b>Dial</b> or  .

If you want to...	Then...
<b>Place a call when another call is active</b>	Press <b>Hold</b> to hold the active call, then press ◀ or ▶ to switch to <b>New Call</b> and press it. Dial, redial, or speed dial a number.
<b>Dial from a Personal Address Book (PAB) entry or a Fast Dial code</b>	Choose <b>Menu &gt; Services &gt; PAB service or Fast Dial service</b> (exact names might vary). Search for a listing by using your keypad to enter letters and press <b>Submit</b> . To dial from a listing, scroll to it and press  .  For help with subscribing to the PAB or Fast Dial service, see the “Subscribing to IP Phone Services” section on page 69.

**Tip**

- If you make a mistake while entering a phone number, press **Clear** to erase one or more digits.
- To redial the last number, you can also press  two times.

## Answering and Ending Calls

If you want to...	Then...
<b>Answer a call</b>	Press and release  (green key) to connect to the incoming call.
<b>Silence the ring for an incoming call</b>	Press  (red key) to silence the ringing. The call continues silently, then forwards to the no answer target, such as voice messaging or another phone.
<b>End the call</b>	Choose <b>EndCall</b> or  (red key) to hang up.

## Muting Calls

To turn off the microphone on your phone, you can use the Mute feature.

If you want to...	Then...
<b>Mute the call</b>	During a call, press <b>MuteOn</b> . The label changes to <b>MuteOff</b> .
<b>Cancel the mute</b>	Press <b>MuteOff</b> . The label changes to <b>MuteOn</b> .

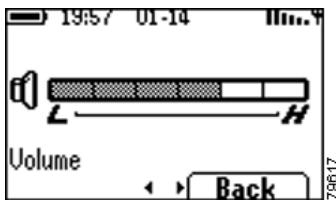
# Adjusting the Speaker Volume

If you want to...	Then...
Change the volume during a call	Press ▲ to adjust the speaker volume for a call on line 1. Press ▲ twice for a call on line 2.
Change the volume for your calls	Press ◀ or ▶ until you see <b>Volume</b> and press it to start adjusting the speaker volume.
Adjust the volume	Increase the volume by pressing ▶ or decrease the volume by pressing ◀ as shown in Figure 0-1. Volume setting remains until you power off the phone.



**Tip** To maintain the speaker volume adjustment after powering off the phone, see the “Change the speaker volume for the active profile” section on page 62.

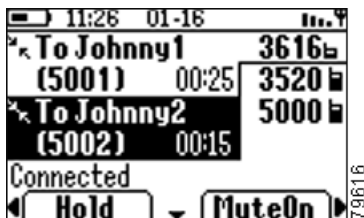
*Figure 0-1 Adjusting the Speaker Volume*



# Placing Calls on Hold

You can have only one active call at a time, so you must place calls on hold while you answer another call.

If you want to...	Then...
Place a call on hold	During a connected call, press <b>Hold</b> . The label changes to <b>Resume</b> .
Resume a held call	Press <b>Resume</b> to reconnect to a holding call.
Choose between two connected calls	Scroll between different calls that are displayed on the screen. See Figure 0-1.



Tip

---

Avoid putting a conference call on Hold because activating Hold usually generates music.

---

## Transferring Calls

You can transfer a connected caller to another party by using the Transfer feature. The *target* is the number that receives the transferred call.

If you want to...	Then...
<b>Transfer a call without talking to the transfer recipient</b>	During a call, press ◀ or ▶ to switch to <b>Transf</b> and press it. Enter the target phone number. When you hear the call ringing, press ◀ or ▶, then press <b>Transf</b> again to complete the transfer operation.
<b>Talk to the transfer recipient before transferring the call</b>	During a call, press ◀ or ▶ to switch to <b>Transf</b> and press it. Enter the target phone number and wait for the call recipient to answer. If the recipient accepts the call, press ◀ or ▶ then press <b>Transf</b> again.  If the recipient refuses the call, press <b>Resume</b> to return to the original call.

## Making Conference Calls

Conference calling allows from three to sixteen parties to participate simultaneously in a call. Your Cisco IP Phone supports several types of conference calls depending on your configuration. The softkeys identify which methods are available on your phone:

- **Confrn**—To establish standard conferences by calling each participant. Standard conference calling is available on most phones.

<b>If you want to...</b>	<b>Then...</b>
<b>Set up a standard conference call by calling participants</b>	<p>During a call, press ◀ or ▶ to switch to Conf. To add another party to the call, press Conf (press ◀ or ▶ to find softkey) and enter the participant's phone number.</p> <p>After the call connects and you have spoken to the participant, press Conf again to add the party to your conference call.</p> <p>Follow this procedure to add each participant to the conference call.</p>
<b>End a standard conference call</b>	Choose EndCall or <i>ℓ</i> to end the conference call.



**Tip** The number of parties that you can add to a conference call is set by your system administrator.

## Forwarding Your Calls to Another Number

You can use the Call Forward All feature to redirect your calls to any phone number, although your system administrator might restrict call forwarding to phone numbers within your company.

<b>If you want to...</b>	<b>Then...</b>
<b>Set up call forwarding on your primary line</b>	<p>Press ◀ or ▶ to switch to CFwdAll. Press CFwdAll and enter a target extension or phone number.</p> <p>The screen displays “Forwarded to (target number).”</p>
<b>Cancel call forwarding on your primary line</b>	<p>Press CFwdAll.</p> <p>The “Forwarded to” message disappears.</p>



- Tip**
- Enter the Call Forward All target number exactly as you would dial it, including any access codes or area codes.
  - You must configure call forwarding for each line on your phone.

# Using Advanced Call Features

---

Advanced call handling tasks require access to special features. Your system administrator might configure these features for your phone depending on your call-handling needs and work environment.

## Parking and Retrieving Parked Calls

You can use the Call Park feature to store a connected call in the Cisco CallManager system, then you or a co-worker can retrieve the parked call from another phone in a conference room or in a co-worker's office.

If you want to...	Then...
<b>Store an active call by using Call Park</b>	During a call, press ◀ or ▶ to switch to <b>Park</b> and press the softkey. The system stores the call and displays the call park number. Note the call park number that you must use to retrieve the parked call.
<b>Retrieve a parked call</b>	If your phone receives a call park notification: <ul style="list-style-type: none"> <li>• Press the PickUp soft key followed by the asterisk (*).</li> <li>• Press the PickUp soft key followed by the call part slot number.</li> </ul>




### Tip

- If the screen does not display a call park number, then the Call Park feature is not available for your phone.
  - You have a limited amount of time to retrieve the parked call before it reverts to ringing at its original destination. See your system administrator for this time limit.
- 

## Redirecting a Ringing Call to Your Phone By Using Call PickUp

Call PickUp allows you to redirect a call that is ringing on a co-worker's phone to your own phone so you can answer it. Your system administrator can set up a Call Pickup group for extensions that share call handling responsibilities.

When you want to answer calls to phones that do not belong to your Call Pickup group, you need to have the call group pickup code. Your system administrator defines Call Pickup groups and group pickup codes.

If you want to...	Then...
<b>Answer a call that is ringing on another phone within your Call Pickup group</b>	Choose any available line on your phone and press ◀ or ▶ to switch to Pickup and press the softkey. Press the asterisk (*) to transfer control of the call to your phone.
<b>Answer a call that is ringing on an extension outside your Pickup group</b>	Choose any available line on your phone and press ◀ or ▶ to switch to GPickup. Dial the pickup group number where the phone is ringing to transfer control of the call to your phone.
 <b>Note</b>	<u>Obtain the call group pickup code from the system administrator.</u>



**Tip**

If several calls come in when you activate Pickup or Group Pickup, the first unanswered call rings at your phone.

## Understanding Shared Lines

Your system administrator might give you a “shared” line. Shared line features do not apply to standard, unshared lines. Typically, a shared line has two main uses:

- One person applies a shared line to multiple phones—For example, your shared line, 23456, applies to your wireless IP phone and to your office desktop phone. An incoming call to 23456 rings on your desk and on your wireless IP phone, and you can use either phone to answer the call.
- Multiple people share a line—For example, you are a manager who shares a line and extension number with your assistant. An incoming call to the extension rings on both of the phones.

If you want to...	Then...
<b>Move a call to another shared line</b>	Place the shared-line call on hold. Press <b>Resume</b> on another phone with the shared line.

# Using the Phone Book and Speed Dial Features

The Directory menu provides access to these features:



- Personal Phone Book
- Speed Dial
- Corporate Directory

To help you set up and use these features, this chapter includes the following sections:

- Using the Phone Book, page 29
- Configuring Speed Dial Hot Keys, page 31

Your Cisco Wireless IP Phone 7920 comes with a local phone book feature. Use the Phone Book option to view phone book entries, to add or edit phone book entries, and to set up speed-dial numbers. You can access entries in your phone book by pressing the PhBook softkey.

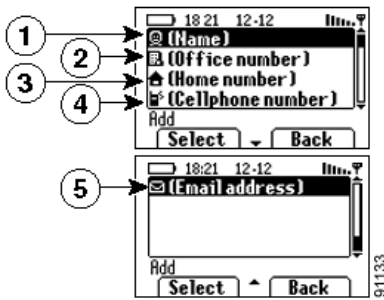
## Using the Phone Book

If you want to...	Then...
<b>Browse the phone book to see a list of entries</b>	Press <b>PhBook</b> . The phone displays entry names. If there are no phone book entries, “Empty” displays.
<b>View an entry in the Phone Book</b>	Scroll to the desired phone book entry and press <b>Detail</b> . The phone book entry item displays the name with the list of associated phone numbers.
<b>Dial a number from the Phone Book</b>	Press <b>PhBook</b> and scroll to an entry. Press  to dial the number. The phone dials the first number in the phone book entry.
<b>Dial a specific number from the Phone Book</b>	Press <b>PhBook</b> and scroll to an entry. Press <b>Detail</b> and scroll to the desired phone number. Press  to dial the number.
<b>Edit an existing phone book entry</b>	Press <b>PhBook</b> and scroll to an entry. Press <b>Detail</b> and scroll to the item in the entry to edit. See Figure 7. Press <b>Edit</b> and follow the instructions in the “Entering and Editing Text” section on page 26. When you have edited the entry, press <b>OK</b> , then press <b>Save</b> .

## Adding or Changing Entries in the Phone Book

You can add a new phone book entry or change an existing entry by using the Directory menu. You must enter the phone number for each phone book entry exactly as you would dial the number. You can add the information as shown in Figure 7.

**Figure 7** Phone Book Entry



<b>1</b>	Contact person's name
<b>2</b>	Office phone number entry
<b>3</b>	Home phone number entry
<b>4</b>	Cellular phone number entry
<b>5</b>	E-mail address entry

<b>If you want to...</b>	<b>Then...</b>
<b>Browse the phone book entries</b>	Press <b>Menu</b> and select <b>Directory &gt; Phone Book</b> then select <b>Names</b> to see the entries.
<b>View the information in a phone book entry</b>	Scroll to a phone book entry and press <b>Detail</b> .
<b>Add a new phone book entry</b>	<p>Choose <b>Menu &gt; Directory &gt; Phone Book &gt; Add</b>. The screen displays as shown in Figure 7.</p> <p>Scroll to the entry item and press <b>Select</b>. Enter the name or phone number by following instructions in the “Entering and Editing Text” section on page 26.</p> <p>When you have finished the entry, press <b>OK</b>, then press <b>Save</b>.</p> <p>Press <b>Back</b> to return to the Directory menu.</p>

If you want to...	Then...
<b>Edit an existing phone book entry</b>	<p>Choose <b>Menu &gt; Directory &gt; Phone Book &gt; Names</b>, then scroll to an entry. Press <b>Detail</b> and scroll to the item to edit, such as Home number.</p> <p>Edit the item by following instructions in “Entering and Editing Text” section on page 26.</p> <p>When you have finished, press <b>OK</b>, then press <b>Save</b>.</p> <p>Press <b>Back</b> to return to the Directory menu.</p>
<b>Erase a phone book entry</b>	<p>Choose <b>Menu &gt; Directory &gt; Phone Book &gt; Names</b>, then scroll to an entry. Press <b>◀</b> or <b>▶</b> to switch to <b>Erase</b>.</p> <p>Press <b>Erase</b> and press <b>OK</b> to confirm that you want to erase the phone record.</p> <p>Press <b>▶</b> to switch to <b>Back</b> then press the softkey to return to the Directory menu.</p>

**Tip**

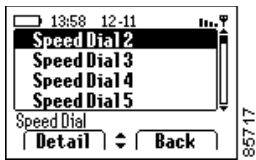
- When adding external phone numbers, enter your external access number, such as 9, and the entire telephone number, including 1 and the area code.
- To use the corporate directory, see the “Dial from a corporate directory listing” section on page 30.


## Configuring Speed Dial Hot Keys

On the Cisco Wireless IP Phone 7920 keypad, the numeric keys (2-9) are hot keys that access speed-dial numbers. You can assign phone numbers to eight Speed Dial hot keys. The number 1 key is reserved for accessing the voice messaging system.


If you want to...	Then...
<b>Access the Speed Dial menu</b>	<p>Press <b>Menu</b> and select <b>Directory &gt; Phone Book</b>. Scroll to and select <b>Speed Dial</b>. The Speed Dial hot keys display as shown in Figure 8.</p> <p>Check marks appear when the Speed Dial number hot keys already have assigned phone numbers.</p>
<b>View the phone number assigned to the Speed Dial hot key</b>	<p>Scroll to the Speed Dial number hot key and press <b>Detail</b>. See Figure 8.</p>

**Figure 8 Speed Dial Menu**



If you want to...	Then...
<b>Assign a phone number to a Speed Dial hot key.</b>	Scroll to an available Speed Dial number hot key and press <b>Detail</b> . Press <b>Edit</b> to enter the information. See the “Entering and Editing Text” section on page 26. Press <b>OK</b> to save the speed-dial number, then <b>Back</b> to exit the menu.
<b>Change the phone number on a Speed Dial hot key</b>	Scroll to a configured Speed Dial number and press <b>Detail</b> . Press <b>Edit</b> to change or clear an existing phone number. To confirm the change, press <b>OK</b> , then <b>Back</b> to exit the menu.
<b>Speed dial a phone number using a Speed Dial hot key</b>	Press and hold  (2-9) for the Speed Dial number that you want to use. The phone displays and dials the number stored for that hot key. See the “Speed dial a phone number using a Speed Dial hot key” section on page 30.
<b>Add or change Speed Dial numbers on your screen</b>	Log in to your IP Phone User Options web page and choose your Cisco 7920 device. Choose <b>Add/Update Your Speed Dials...</b> from the main menu.  You can set up or change speed-dial numbers by entering the phone number and name on this web page.  Refer to <i>Customizing Your Cisco IP Phone on the Web</i> for more information.


 **Tip**


- Your screen displays the first few names for speed-dial numbers set up on the User Options web page. To make a call from your speed dial list, scroll to the name and press .
- You must enter the external phone number exactly as you would dial it, including an access code, such as 9, and the area code, if required.
- To make a call using Speed Dial, see the “Speed dial a phone number using a Speed Dial hot key” section on page 30.

## Using Voice Messaging and Call History Logs

The Cisco Wireless IP Phone 7920 main menu provides access to the voice messaging service and to call history logs.

### Playing Voice Messages

When the phone displays, “You have voice mail,” you can access your messages by using the Messages menu or the shortcut key .

If you want to...	Then...
<b>Set up and personalize your voice message service</b>	Press <b>Menu</b> , then press <b>▶</b> to select <b>Messages</b> . Select <b>Voice Mail Box</b> and follow the voice instructions. Your system administrator will provide a default password for your voice messaging service.
<b>Access and play your voice messages</b>	Press <b>Menu</b> , then press <b>▶</b> to select <b>Messages</b> . Select <b>Voice Mail Box</b> . Enter your password and follow the voice instructions to listen to your messages.
<b>Access your voice messages using the shortcut key.</b>	While in standby mode, press and release  , for immediate access. Enter your voice messaging password and follow the voice instructions to listen to your messages.




#### Tip

- For accurate and detailed information about using your voice message service, refer to the documentation for your voice messaging system.
- For security reasons, you should change your default password as soon as possible.

## Viewing and Placing Calls from the Call History Menu

You can view a list of missed calls, received calls, and placed calls in the Call History logs. You can dial a number directly from one of the lists.

If you want to...	Then...
<b>View a call that you missed, received, or placed</b>	Press <b>Menu</b> , then press ◀ or ▶ to select <b>Call History</b> . Scroll to and select <b>Missed Calls</b> , <b>Received Calls</b> , or <b>Placed Calls</b> . Scroll to the appropriate number, then press <b>Detail</b> to see information about the call.
<b>Dial a number from the Missed Calls, Received Calls, or Placed Calls list</b>	Scroll to the number that you want to dial and press <b>Detail</b> . If you need to edit the number in the log (to add or to remove a prefix), press <b>EditDial</b> followed by ◀ or ▶ to reposition the cursor or erase digits. Use the keypad to enter digits. Press  to dial the number.
<b>Erase the Call History</b>	Press <b>Menu &gt; Call History</b> . Scroll to and select <b>Erase Call History</b> . Press <b>OK</b> to erase the entire call history. Or press <b>Cancel</b> to return to the Call History menu. After pressing <b>OK</b> , all call history logs are empty.

# Using and Changing Profiles

The Cisco Wireless IP Phone 7920 comes with the following types of profiles:

- User Profiles, page 35
- Network Profiles, page 38

When you access the Profiles menu, you might see “Not Available” on the screen depending on how the system administrator configured your phone.

## User Profiles

Predefined user profiles allow you to quickly change rings and tones on your phone. You can choose between the following profiles for different work environments.

- Normal
- Silent
- Meeting
- Outdoors

For example, when you are working outside, choosing the Outdoors profile automatically increases the ring volume and speaker volume. When you choose the Meeting profile, the ring volume is decreased to the lowest level or you can choose the Silent profile and turn off the ringer.

The following table lists the default settings for the user profiles.

Type of Settings	Profiles			
	Normal	Silent	Meeting	Outdoors
Speaker Volume	3	3	3	5
Ring Volume	4	0	1	6
Incoming Call Alert	On	Off	On	On
Vibrating Call Alert	Off	Off	Off	On
Keypad Tones	Off	Off	Off	On
Warning Style	Tone	Off	Off	Tone

## Options for User Profile Settings

You can choose a profile from the Profiles menu and use the default settings, or you can adjust the settings to meet your needs.

For example, you can choose the Normal profile and change the Warning Tone from Tone to Vibrate.

Table 0-1 shows the profile settings and the options that are available in the Profiles menu.

**Table 0-1** Options for Changing Profile Settings

Profile Settings	Setting Options		
Activate	Select	Deselect	
Speaker Volume	Up	Down	
Ring Volume	Up	Down	
Incoming Call Alert	On	Off	
Vibration Call Alert	On	Off	
Keypad Tones	On	Off	
Warning Style	Off	Tone	Vibration

## Configuring User Profiles

You can activate a profile, then you can adjust the settings for the profile.

If you want to...	Then...
<b>View the active User Profile</b>	Press <b>Menu</b> , then press ► or ◀ to switch to <b>Profiles</b> and press <b>Select</b> . Scroll to <b>User Profiles</b> and press <b>Select</b> . The activated profile has a check mark next to it.
<b>Choose a different profile</b>	Scroll to a different profile and press <b>Select</b> to access the settings for that profile. Select <b>Activate</b> to change the profile. The check mark appears next to the new profile. Press <b>Back</b> to return to the menu.
<b>Change the speaker volume for the active profile</b>	Choose <b>Menu &gt; Profiles &gt; User Profile</b> , then select the active profile. Scroll to <b>Speaker Volume</b> and select it. Press ► to increase the volume or ◀ to decrease the volume. Press <b>Back</b> to make the change.

If you want to...	Then...
<b>Change the ring volume for the active profile</b>	Choose <b>Menu &gt; Profiles &gt; User Profile</b> , then select the active profile. Scroll to and select <b>Ring Volume</b> . Press ► to increase the volume or ◀ to decrease the volume. Press <b>Back</b> to confirm the change.
<b>Change the incoming call alert for the active profile</b>	Choose <b>Menu &gt; Profiles &gt; User Profile</b> , then select the active profile. Scroll to and select <b>Incoming Call Alert</b> . Scroll to and select <b>Off</b> or <b>On</b> to control the incoming call alert function.
<b>Change the vibrating call alert for the active profile</b>	Choose <b>Menu &gt; Profiles &gt; User Profile</b> , then select the active profile. Scroll to and select <b>Vibration Call Alert</b> . Scroll to and select <b>Off</b> or <b>On</b> to control the vibrating call alert function.
<b>Change the keypad tone for the active profile</b>	Choose <b>Menu &gt; Profiles &gt; User Profile</b> , then select the active profile. Scroll to <b>Keypad Tone</b> and select it. Scroll to and select <b>Off</b> or <b>On</b> to control the keypad tone function.
<b>Change the warning style for the active profile</b>	Press <b>Menu &gt; Profiles &gt; User Profile</b> , then select the active profile. Scroll to <b>Warning Style</b> and select it. Scroll to one of the following: Off—Sends no warning messages. Tone—Makes a sound with warning messages. Vibration—Vibrates with warning messages. Press <b>Select</b> to change the warning style.

**Tip**

- If the phone detects a weak signal or a low battery, it displays warning messages and sends the warning tone or vibration.
- A check mark displays next to the active profile setting.
- To maintain the speaker volume setting after powering off the phone, change the volume in the active profile.

# Network Profiles

Network profiles provide predefined settings for access to the wireless network and for authentication and encryption for your system. Your system administrator defines network profiles for you. You might have more than one network profile available to you. Predefined network profiles allow you to quickly change network configurations for different locations.

For example, when you are working in your local office, you can choose the network profile for that location so you can access the wireless network and authenticate with the security services. When you travel to another office, the wireless network might require a different SSID and authentication settings. You can quickly select the network profile for that location without having to manually change the 802.11b configuration settings.

## Choosing a Network Profile

You can choose between up to four network profiles for using your Cisco Wireless IP Phone 7920 in different locations. You can set your phone to automatically scan the profiles and select the network profile with the correct SSID for a specific wireless LAN (WLAN) location.

Your system administrator sets up and maintains the network profiles. Consult with your system administrator if you need to change settings in a profile.

If you want to...	Then...
<b>View the active Network Profile</b>	Press <b>Menu</b> , then press ◀ or ▶ to switch to <b>Profiles</b> and press <b>Select</b> . Scroll to <b>Network Profile</b> and press <b>Select</b> . The activated profile has a check mark next to it.
<b>Automatically connect to the WLAN by scanning all profiles.</b>	Choose <b>Menu &gt; Profiles &gt; Network Profile</b> , then scroll to <b>Auto</b> and press <b>Select</b> . Select <b>Activate</b> to change the profile. The check mark appears next to <b>Auto</b> . Press <b>Back</b> to return to the menu.
<b>Choose a different profile</b>	Scroll to a different profile and press <b>Select</b> to access the settings for that profile. Select <b>Apply Change</b> to select the new profile. The check mark appears next to the new profile.



### Tip

- You can enter or change your LEAP username and password by choosing **Network Profiles > “your active profile” > 802.11b Configuration > LEAP**. See the “Setting Passwords” section on page 24.
- Do not make changes to settings in to your network profiles without consulting your system administrator first.

- Your system administrator has detailed information about the menu options and settings in the Network Profiles menu.
  - To view the current network configuration on your phone, see the “Viewing the Network Configuration” section on page 79.
-

# Using Cisco IP Phone Services

---

Because your Cisco Wireless IP Phone 7920 is a network device, it can share information with other network devices in your company, including your computer.

You can establish, customize, and enable phone services, and control settings and features from your computer using the Cisco CallManager User Options web pages. After you subscribe to IP Phone services, you can access them from your phone.

If you need additional assistance with the User Options web pages, refer to the *Customizing Your Cisco IP Phone on the Web* guide, which is available on [www.cisco.com](http://www.cisco.com).

## Logging In to the User Options Web Pages

---

**Step 1** Obtain a User Options URL, user ID, and default password from your system administrator.

**Step 2** Open a web browser on your computer and enter the URL (provided by your system administrator) and log on.

**Step 3** From the general menu, choose IP Phone 7920 in the “Select a device” drop-down list.

After you make your selection, a menu appears with options appropriate for your device type.



### Tip

- Select IP Phone 7920 from the menu page to see all of your options.
  - Click **Update** to apply and save your changes.
  - Click **Return to the Menu** to get back to the context-sensitive menu.
  - Click **Log Off** to exit the User pages.
- 

## Subscribing to IP Phone Services

Before you can access IP Phone services on your phone, you need to subscribe to them by using your computer to access the User Options web pages. Contact your system administrator for your User Options URL.

Services can include:

- Web-based information, such as stock quotes, movie listings, and weather reports
- Network data, such as corporate calendars and searchable directories

- Phone features, such as a Personal Address Book (PAB) and Fast Dial service from your PAB.

If you want to...	Then do this after you log in...
<b>Subscribe to a service</b>	Choose <b>Configure your Cisco IP Phone Services</b> . Select a service from the “Available Services” drop-down list and click <b>Continue</b> . Enter more information upon request (such as a zip code or PIN), then click <b>Subscribe</b> .
<b>Change or end subscriptions</b>	Choose <b>Configure your Cisco IP Phone Services</b> . Click a service in the “Your Subscribed Services” panel. Click <b>Update</b> after making changes, or click <b>Unsubscribe</b> .

## Accessing IP Phone Services

After subscribing to phone services, you can access those services from your phone menu.

If you want to...	Then...
<b>View available information services</b>	Choose <b>Menu</b> , then press <b>▶</b> to switch to <b>Services</b> . Press <b>Select</b> to see your subscribed services.
<b>Access an information service</b>	Choose <b>Menu &gt; Services</b> . Scroll to the service that you want, then press <b>Select</b> to see service information details.
<b>Dial a number from your Personal Address Book (PAB)</b>	Choose <b>Menu &gt; Services</b> . Scroll to and select <b>PAB service</b> . Search for a listing by entering letters and press <b>Submit</b> . If you get more than one result, scroll to the desired number. Press <b>EditDial</b> to add predial digits or change the number. To dial from a listing, scroll to it and press <b>☎</b> .
<b>Exit from Services</b>	Press <b>Exit</b> and <b>Back</b> to return to the main screen or press <b>⏪</b> .



### Tip

- The Service menu can appear as “SvcS” softkey on the main menu. Your system administrator sets up this option.
- You must subscribe to the Personal Address Book before you can access this service on your Cisco Wireless IP Phone 7920.

# Customizing Phone Settings and Viewing Phone Status

---

You can personalize your phone by adjusting settings such as ring tones and screen messages.

You can secure access to your phone by enabling the phone lock feature. After powering on the phone, you must enter a password before the phone can authenticate with the wireless network.

When you access the Phone Settings menu, you might see only Phone Status on the screen depending on how the system administrator configured your phone.

For troubleshooting phone problems with your system administrator, you might need to view information about the phone software or the network configuration. See the following sections for this information:

- Viewing Phone Status, page 44
- Viewing the Network Configuration, page 45

## Change Phone Settings

You can choose between several phone setting options for your Cisco Wireless IP Phone 7920 by using the Phone Settings menu. If the Phone Settings menu options do not appear, your system administrator has restricted local configuration for the phone.

## Changing Ring Tone Settings

To access phone settings, press **Menu**, then press ◀ or ▶ to switch to the Phone Settings menu. Select **Phone Settings** and the list of phone setting options appear.

<b>If you want to...</b>	<b>Then...</b>
<b>Change ring tones for each extension</b>	Scroll to and select <b>Ring Tones</b> , then scroll to and select <b>Select Ring Tone</b> .  Choose the extension to assign with a ring tone, then scroll to and select the desired ring tone. The chosen ring tone plays and a check appears next to it.  You can choose among two default ring tones and one user downloaded ring tone.

If you want to...	Then...
<b>Download ring tones from Cisco CallManager</b>	<p>Choose <b>Ring Tones &gt; Download Ring Tone</b>. Scroll to and select the desired ring tone from list. Press ◀ or ▶ until you see <b>Play</b> and press it to hear the selected ring tone.</p> <p>Switch to <b>Select</b> and press it. A check mark appears next to the downloaded ring tone. Press <b>Back</b>.</p> <p>The downloaded ring tone appears in the list of ring tones for your phone.</p>

## Changing Phone Display Settings

Choose **Menu > Phone Settings** to change settings that control the phone screen and displayed information.

If you want to...	Then...
<b>Choose the language that displays on the phone screen.</b>	<p>Scroll to and select <b>Language</b>, then scroll to and select the desired language. A check mark displays next to the selected language.</p> <p>The screen immediately changes to the selected language.</p>
<b>Change the start up message on the phone screen</b>	<p>Scroll to and select <b>Greeting Message</b>, then press <b>Edit</b>. Enter a message up to 15 characters in length. See the “Entering and Editing Text” section on page 26. Press <b>OK</b> to save the change, then <b>Back</b> to return to the Phone Settings.</p>
<b>Change the main phone screen message</b>	<p>Scroll to and select <b>Welcome Message</b>, then press <b>Edit</b>. Enter a message up to 10 characters in length. See the “Entering and Editing Text” section on page 26. Press <b>OK</b> to save the change, then <b>Back</b> to return to Phone Settings.</p>
<b>Change the back light for the phone display</b>	<p>Scroll to and select <b>Backlight</b>. Scroll to <b>Off</b> or to <b>On</b> and press <b>Select</b>.</p>

## Changing Phone Access Settings

Choose **Menu > Phone Settings** menu to change these settings that control access to the phone and phone records.

<b>If you want to...</b>	<b>Then...</b>
<b>Require the use of a password to unlock the phone when powering it on</b>	Scroll to and select <b>Phone Lock</b> , then scroll to and select <b>On/Off</b> . Scroll to <b>Off</b> to disable the phone lock or <b>On</b> to require a phone lock password and press <b>Select</b> .
<b>Change the phone lock password</b>	Scroll to and select <b>Phone Lock</b> , then scroll to and select <b>Password</b> . Press <b>Edit</b> to enter the phone lock password (up to 10 numbers including * or #). Press <b>OK</b> to confirm the change and <b>Back</b> to return to Phone Settings.  The default password is set to 12345.



### Tip

- If you enable the Phone Lock feature and have not changed the password, enter **12345** (default password) to unlock the phone.
- If you change the Phone Lock password and forget it, you must contact the system administrator to have the phone unlocked and reset. You will lose all your personal settings including your Phone Book entries.

## Viewing Phone Status

For troubleshooting purposes, you might need to view the software, firmware, and hardware releases on your phone that are described in the table below.

<b>If you want to...</b>	<b>Then...</b>
<b>View the Phone Status Options</b>	Press <b>Menu</b> and press ◀ or ▶ to switch to the Phone Settings menu. Select <b>Phone Settings</b> , then select <b>Phone Status</b> .
<b>View the current configuration filename</b>	Scroll to and select <b>Current Config File</b> to see the number.
<b>View network statistics</b>	Scroll to and select <b>Network Statistics</b> to see your network connection time and other statistics.
<b>View the firmware version number</b>	Scroll to and select <b>Firmware Info</b> . Then scroll to and select <b>Firmware Version</b> .
<b>View the board support package (Bsp) load ID</b>	Scroll to and select <b>Firmware Info</b> . Scroll to and select <b>Bsp Load ID</b> .

<b>If you want to...</b>	<b>Then...</b>
<b>View the boot load ID</b>	Scroll to and select <b>Firmware Info</b> . Scroll to and select <b>Boot Load ID</b> .
<b>View the hardware information</b>	Scroll to and select <b>Hardware Info</b> to see the current Hardware release.

## Viewing the Network Configuration

For troubleshooting purposes, you might need to view the current network settings for your phone that are described in the table below.

When you access the Network Config menu, you might see “Not Available” on the screen depending on how the system administrator configured your phone.

<b>If you want to...</b>	<b>Then...</b>
<b>View the current network configuration</b>	Choose <b>Menu &gt; Network Config &gt; Current Config</b> to see the following settings: <ul style="list-style-type: none"> <li>• DHCP enable</li> <li>• DHCP server</li> <li>• IP address for phone</li> <li>• Subnet mask</li> <li>• Hostname for phone</li> <li>• Primary gateway</li> <li>• Primary TFTP server</li> <li>• Cisco CallManager servers (1-5)</li> </ul>
<b>View the MAC address for the phone</b>	Choose <b>Menu &gt; Network Config &gt; MAC Address</b> .
<b>View the wireless network settings for phone</b>	Choose <b>Menu &gt; Network Config &gt; 802.11b Configuration</b> to see the following settings: <ul style="list-style-type: none"> <li>• Associated access point (AP) MAC address</li> <li>• Associated AP SSID</li> <li>• Network type</li> <li>• Current user profile</li> <li>• Current network profile</li> <li>• Key management used</li> <li>• Cipher used</li> </ul>



**Tip**

- 
- The system administrator can disable access to configurable menus on the Cisco Wireless IP Phone 7920.
  - The system administrator has information about the network configuration settings that might display in this menu.
  - The Site Survey option is a utility for checking access point associations.
-

# Menu Diagrams and Display Messages

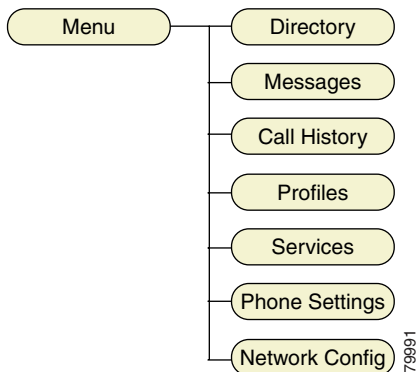
---

## Menu Diagrams

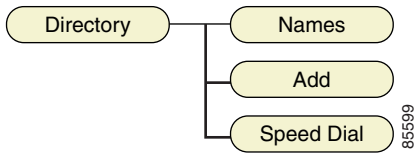
The following provides a list of menu diagrams for the Cisco Wireless IP Phone 7920, and contains the following sections:

- Cisco Wireless IP Phone 7920 Menu
- Directory Menu
- Messages Menu
- Call History Menu
- Profiles Menu
- Phone Settings Menu
- Network Config Menu
- Network Config Menu>TFTP Option Submenu
- Network Config Menu>DHCP Enable/Disable Submenu
- 802.11b Menu

**Figure 9** Cisco Wireless IP Phone 7920 Menu



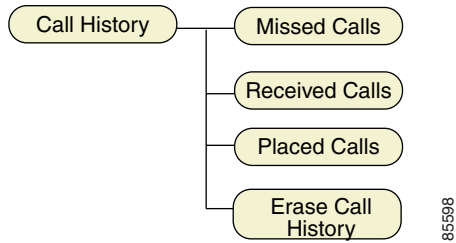
**Figure 10 Directory Menu**



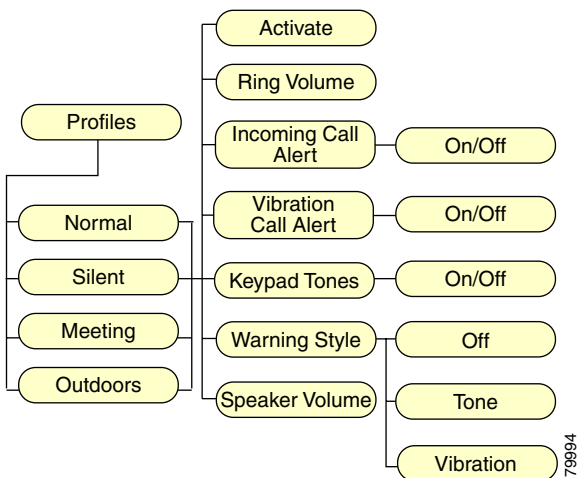
**Figure 11 Messages Menu**



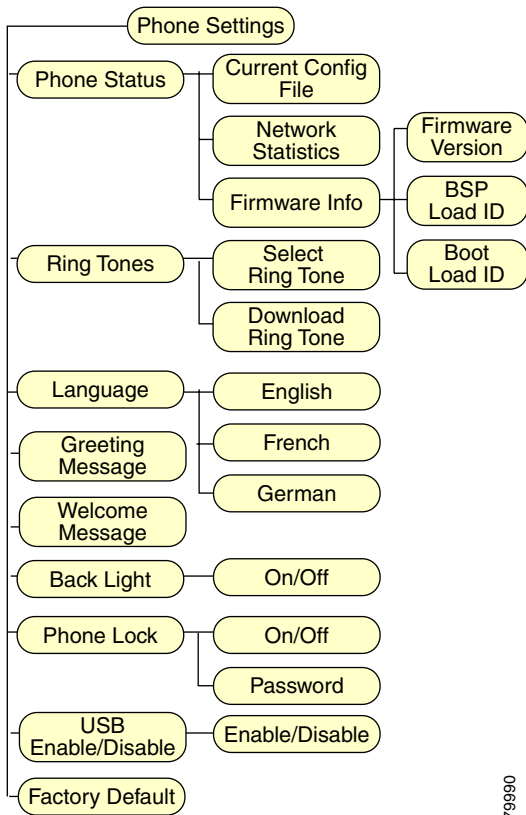
**Figure 12 Call History Menu**



**Figure 13 Profiles Menu**

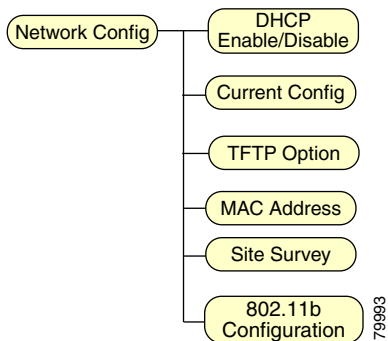


**Figure 14 Phone Settings Menu**



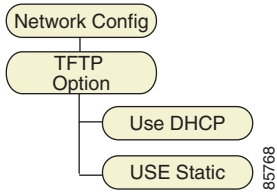
79990

**Figure 15 Network Config Menu**



79993

**Figure 16 Network Config Menu>TFTP Option Submenu**



**Figure 17 Network Config Menu>DHCP Enable/Disable Submenu**

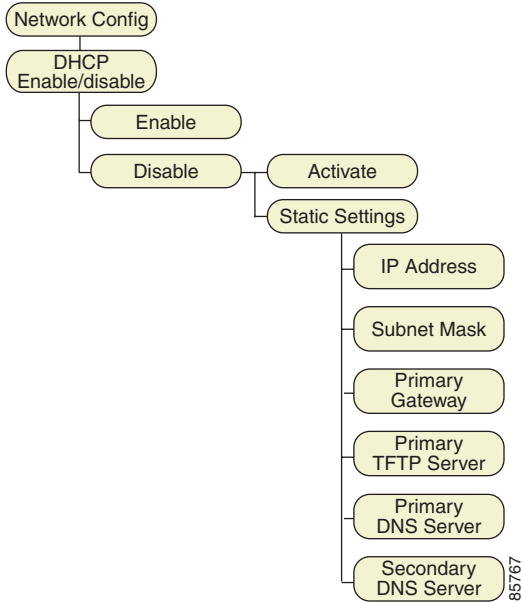
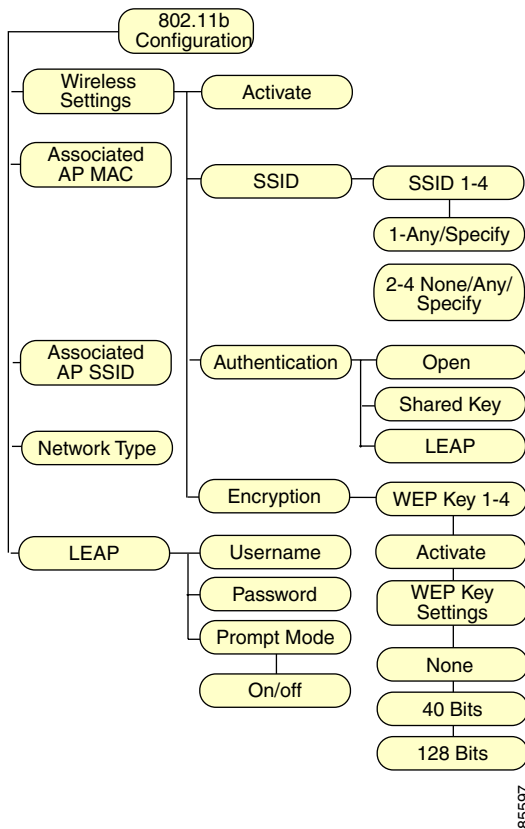


Figure 18 802.11b Menu



85597

## Display Messages

The following provides a list of messages that are displayed on the user interface of the Cisco Wireless IP Phone 7920, and contains the following sections:

- Informational Messages
- Error Messages
- Warning Messages

## Informational Messages

Informational messages are displayed to inform you of an activity or process that is taking place on your phone, or of the status of the phone.

### **Authenticating with AP**

The phone is authenticating with the access point (AP).

### **Authentication OK**

The phone successfully authenticates with the AP.

### **Associating with AP**

The phone finished the authentication and is associating with the AP.

### **Association OK**

The phone has successfully associated with the AP.

### **Authenticating LEAP**

If LEAP is activated, the phone will perform LEAP authentication after associated with the AP.

### **LEAP authentication OK**

The phone has successfully performed the LEAP authentication on the AP.

### **Configuring IP network**

The phone is obtaining the IP address from the DHCP server.

### **Downloading load ID**

The phone is downloading the load ID from the TFTP server.

### **Downloading config file**

The phone is downloading the configuration file from the TFTP server.

### **Updating firmware**

The phone is downloading the firmware and updating the firmware on the phone. Do not turn off the phone until you see the “Phone Reset (Update OK)” message.

### **Connecting to CallManager**

The phone is connecting to the Cisco CallManager.

**Registering to CallManager**

The phone is registering to the Cisco CallManager.

**You have voice mail**

You have a voice mail in your mailbox.

## Error Messages

Error messages are displayed to let you know that an error has occurred. This error may prevent you from connecting to the network or from using the phone. You may need to contact the system administrator to resolve the problem.

**Authentication failed**

The phone failed to authenticate with the AP.

**Association failed**

The phone failed to associate with the AP.

**LEAP authentication failed**

The LEAP authentication on the phone has failed. Contact your system administrator.

**Duplicate IP address**

The current IP address on the phone is duplicated in the network. Contact your system administrator.

**No service-IP config. failed**

The phone failed to obtain the IP address from DHCP server.

**No service-No TFTP server**

The phone failed to find the TFTP server. Contact your system administrator.

**No service-TFTP not responding**

The TFTP server is not responding. Contact your system administrator.

**No service-TFTP connection failed**

The phone failed to connect to the TFTP server. Contact your system administrator.

**CallManager Down**

The Cisco CallManager is not functioning at this time. Contact your system administrator.

**No CallManager found**

The phone is not able to detect the Cisco CallManager in the network.

**No AP found**

The SSIDs set on the phone do not match any of the Service Set Identifiers (SSIDs) of the APs in the network.

**No Network**

The phone is not able to connect to the network. Contact your system administrator.

## Warning Messages

Warning messages are displayed when the phone detects a condition that may disrupt your phone service.

**Weak signal detected**

The signal quality is low.

**Battery Low**

The battery energy level is low.



## Index

---

### B

- basic phone tasks **22**
- battery
  - battery charging message **12**
  - charging complete message **13**
  - disposal warning **10**
  - handling warning **9**
  - indicator bar **13**
  - installing and removing **11**
  - safety notices **10**
  - standard **7**

### D

- dialing a number from the Directory **35, 40, 42**
- display indicators **17**

### E

- emergency services warning **9**
- entering and editing text **20**
- explosive gas warning **10**

### I

- installation warning **9**

### L

- lightning activity warning **9**

### M

- menus
  - 802.11b **51**
  - Call History **48**
  - Directory **48**
  - Messages **48**
  - Network Config **49**
  - Phone Settings **49**
  - Profiles **48**

### N

- notices
  - for battery safety **10**

### P

- phone package contents **7**
- phone records **35, 40, 42**
- power supply, connecting **12**
- product disposal warning **9**

## **S**

safety warnings **8**

switching the phone on and off **13**

Symbol table **21**

## **W**

warnings

definition **8**

for battery disposal **10**

for battery handling **9**

for emergency services **9**

for explosive gas **10**

for installation **9**

for lightning activity **9**

for product disposal **9**













**Corporate Headquarters**  
Cisco Systems, Inc.  
170 West Tasman Drive  
San Jose, CA 95134-1706  
USA  
www.cisco.com  
Tel: 408 526-4000  
800 553-NETS (6387)  
Fax: 408 526-4100

**European Headquarters**  
Cisco Systems International BV  
Haarlerbergpark  
Haarlerbergweg 13-19  
1101 CH Amsterdam  
The Netherlands  
www-europe.cisco.com  
Tel: 31 0 20 357 1000  
Fax: 31 0 20 357 1100

**Americas Headquarters**  
Cisco Systems, Inc.  
170 West Tasman Drive  
San Jose, CA 95134-1706  
USA  
www.cisco.com  
Tel: 408 526-7660  
Fax: 408 527-0883

**Asia Pacific Headquarters**  
Cisco Systems, Inc.  
168 Robinson Road  
#28-01 Capital Tower  
Singapore 068912  
www.cisco.com  
Tel: +65 6317 7777  
Fax: +65 6317 7799

**Cisco Systems has more than 200 offices in the following countries. Addresses, phone numbers, and fax numbers are listed on the Cisco Web site at [www.cisco.com/go/offices](http://www.cisco.com/go/offices)**

Argentina • Australia • Austria • Belgium • Brazil • Bulgaria • Canada • Chile • China PRC • Colombia • Costa Rica • Croatia • Cyprus • Czech Republic • Denmark • Dubai, UAE  
Finland • France • Germany • Greece • Hong Kong SAR • Hungary • India • Indonesia • Ireland • Israel • Italy • Japan • Korea • Luxembourg • Malaysia • Mexico  
The Netherlands • New Zealand • Norway • Peru • Philippines • Poland • Portugal • Puerto Rico • Romania • Russia • Saudi Arabia • Scotland • Singapore  
Slovakia • Slovenia • South Africa • Spain • Sweden • Switzerland • Taiwan • Thailand • Turkey • Ukraine • United Kingdom • United States • Venezuela • Vietnam • Zimbabwe

Copyright © 2005 Cisco Systems, Inc. All rights reserved. CCSF, the Cisco Square Bridge logo, Follow Me Browsing, and StackWise are trademarks of Cisco Systems, Inc.; Changing the Way We Work, Live, Play, and Learn, and iQuick Study are service marks of Cisco Systems, Inc.; and Access Registrar, Aironet, ASIST, BPX, Catalyst, CCDA, CCDP, CCIE, CCIP, CCNA, CCNP, Cisco, the Cisco Certified Internetwork Expert logo, Cisco IOS, Cisco Press, Cisco Systems, Cisco Systems Capital, the Cisco Systems logo, Cisco Unity, Empowering the Internet Generation, Enterprise/Solver, EtherChannel, EtherFast, EtherSwitch, Fast Step, FormShare, GigaDrive, GigaStack, HomeLink, Internet Quotient, IOS, IP/TV, iQ Expertise, the iQ logo, iQ Net Readiness Scorecard, LightStream, Linksys, MeetingPlace, MGX, the Networkers logo, Networking Academy, Network Registrar, Packet, PIX, Post-Routing, Pre-Routing, ProConnect, RateMUX, ScriptShare, SlideCast, SMARTnet, StrataView Plus, SwitchProbe, TeleRouter, The Fastest Way to Increase Your Internet Quotient, TransPath, and VCO are registered trademarks of Cisco Systems, Inc. and/or its affiliates in the United States and certain other countries.

All other trademarks mentioned in this document or Website are the property of their respective owners. The use of the word partner does not imply a partnership relationship between Cisco and any other company. (0501R)

Printed in the USA on recycled paper containing 10% postconsumer waste.